

Underfloor to Desk Solutions



Underfloor to desk solutions from Marshall Tufflex

A comprehensive range of underfloor to desk cable management and prefabricated wiring systems developed for fast, easy and adaptable installation.

Designed for the distribution of power and data services from beneath raised access floors and in-screed systems, several wiring options are available, including the MT32 prefabricated technology that provides seamless connection all the way from the incoming feed to the desktop.

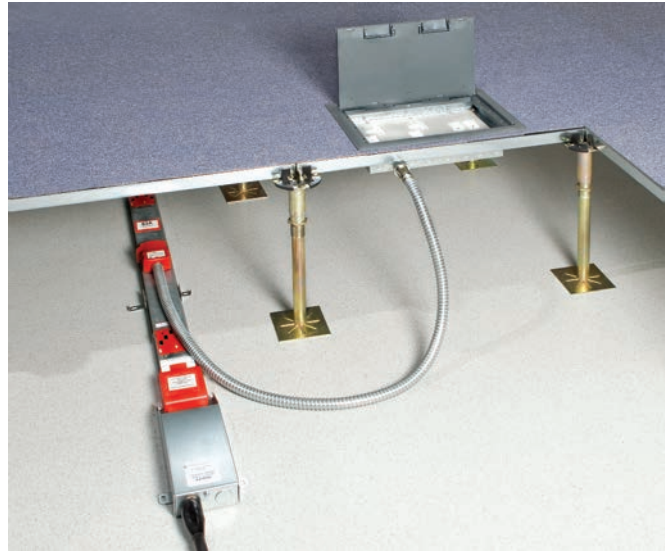

Contents

Underfloor to desk layout	page 4
Powertrack	page 6
Raised floor boxes and grommets	page 8
In-screed flooring system	page 12
MT32 Pre-wired Underfloor Distribution	page 14
Desk Surface Modules	page 16
Power and Data Modules	page 17
Technical Information	page 19

About Marshall Tufflex

Marshall-Tufflex is the UK's leading manufacturer of cable management products. The company specialises in the supply of underfloor to desk systems to the commercial, education and healthcare sectors worldwide.

Our area sales engineers, project managers and technical specialists work closely with electrical consultants, contractors and clients in order to provide the best possible technical and sales support.

Marshall-Tufflex products are designed to meet the latest BS EN ISO standards and to accommodate all building designs and construction parameters. Our bespoke solutions can also be designed and pre-fabricated to meet individual requirements and save time on site.

Introduction

Marshall-Tufflex offer time and cost effective energy distribution systems that provide a fast and flexible interface between floor services and the office environment.



63Amp powertrack system independently tested to meet the very latest standards.



High quality raised floor boxes for areas that experience heavy traffic.



MT32 compatible systems for quick installation.

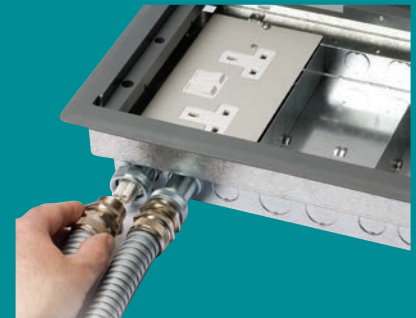

Standards & Environmental

Quality Assurance

Marshall-Tufflex is recognised by the BSI as a firm of Assessed Capability to BS EN ISO 9001:2008.



Q05393
Registration BS EN ISO 9001:2008

Recycling

Marshall-Tufflex actively supports various industry bodies in the use and control of PVC-U based materials, with the aim of increasing awareness and use of recycled material.



Environmental Standards

Marshall-Tufflex is totally committed to achieving high environmental standards and is recognised by the BSI as a firm of Assessed Capability to BS EN ISO 14001:2004.



EMS 539245
Registration BS EN ISO 14001:2004

The company continues to support the Voluntary Commitment to the European Commission with its ongoing Vinyl 2020 programme.

04 | Pre-wired underfloor layouts

A selection of design layouts incorporating MT32 pre-wired technology and powertrack.

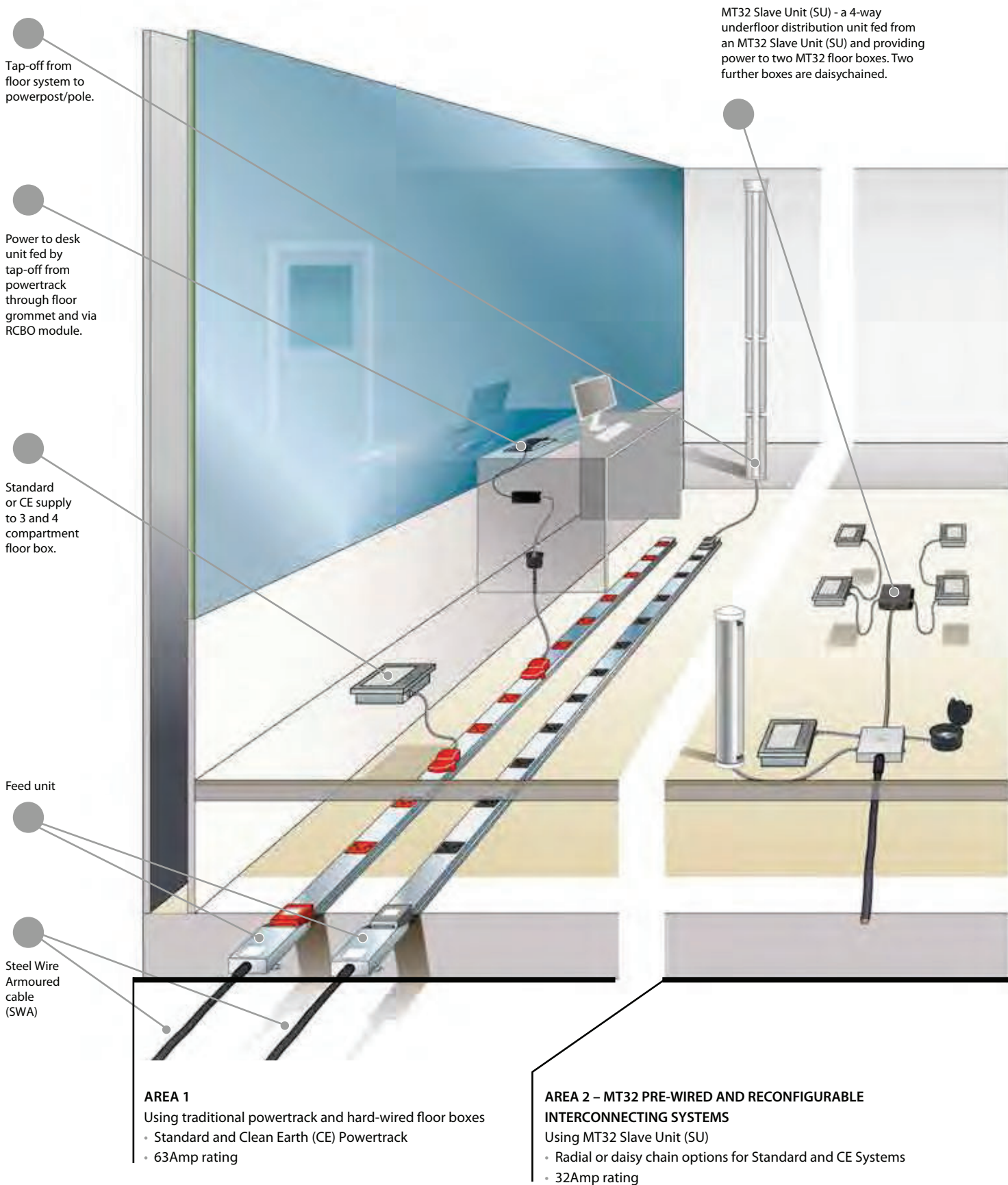

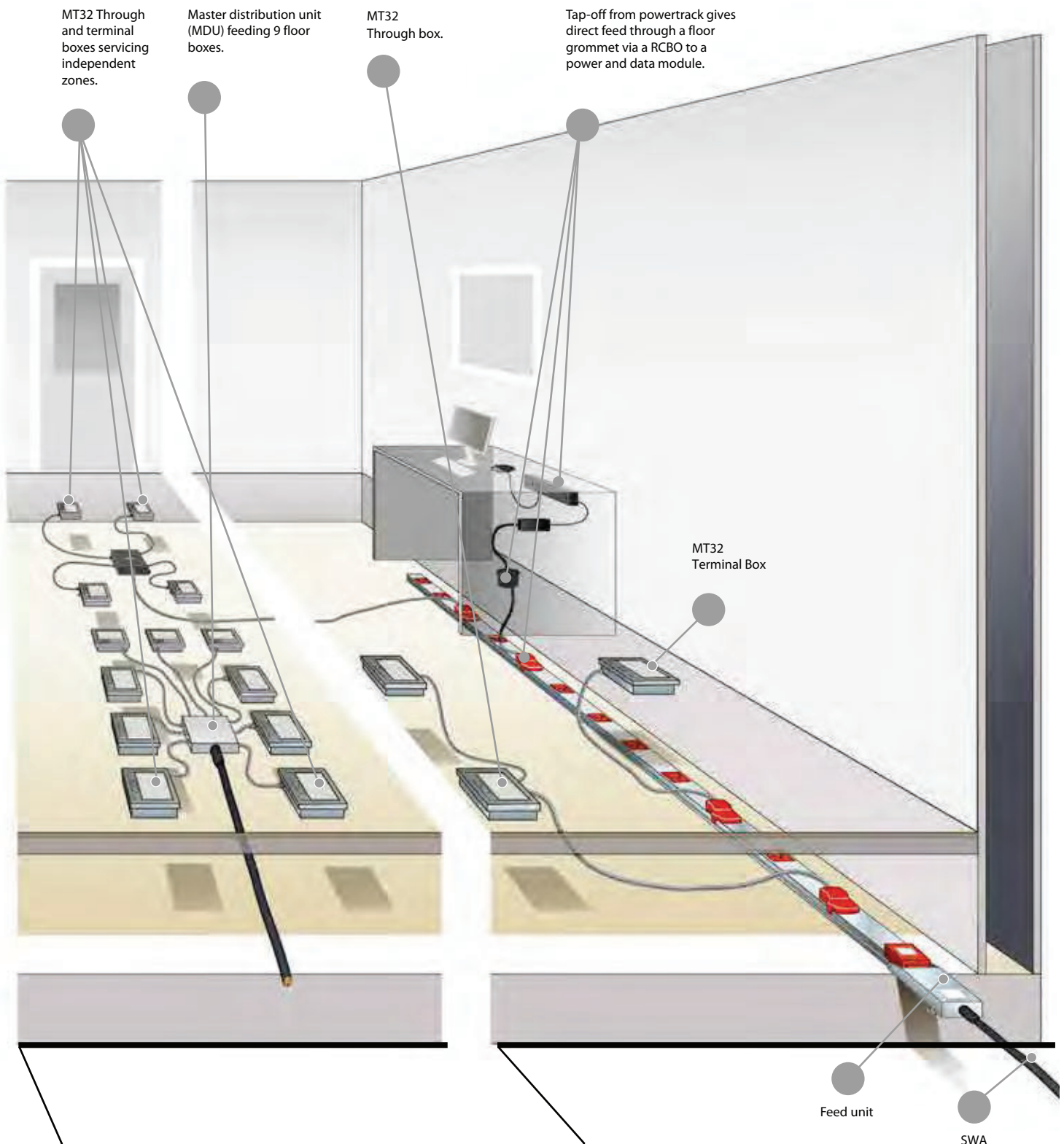

AREA 3 – MT32 PRE-WIRED AND RECONFIGURABLE INTERCONNECTING SYSTEMS
 Using MT32 Slave Unit (SU)
 • Radial or daisy chain options for Standard and CE Systems
 • 32Amp rating

AREA 4 – A COMBINATION OF POWERTRACK AND MT32
 Using 63Amp Standard or CE Powertrack with the MT32 32Amp Underfloor Distribution system.
 • A combination that permits greater floor coverage
 • 32Amp rating

06 | Powertrack

Powertrack is a comprehensive range of underfloor 63Amp powertrack.

Product information

- Each length of track comes complete with pre-assembled coupler, end cap and floor mounting brackets.
- Maximum 63Amp rating
- Tap-offs are key and colour coded for Standard and CE (Clean Earth)
- Tap-offs are 32Amp rated or fused at 13Amp
- Adhesive dust covers protect outlets
- Compatible with MT32 pre-wired floor boxes



Powertrack and fittings are independently tested by Intertek

Identification	
Standard	CE
Standard: Grey CE (Clean Earth): Red	

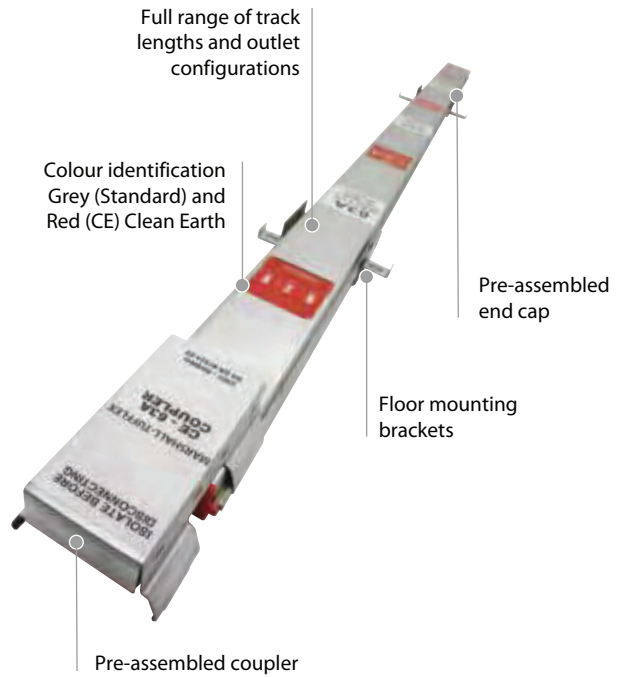

To calculate powertrack lengths required for different floor layouts refer to table on opposite page.

Powertrack
Standard



code	length	Number of outlets	pitch (mm)	pack
UN1112	1.2m	4	300	2
UN1118	1.8m	6	300	2
UN1114	2.4m	8	300	2
UN1116	3.6m	12	300	2

Powertrack
CE (Clean Earth)



code	length	Number of outlets	pitch (mm)	pack
UN1212	1.2m	4	300	2
UN1218	1.8m	6	300	2
UN1214	2.4m	8	300	2
UN1216	3.6m	12	300	2







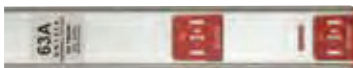

Standard
Rated current 63Amp



Low Noise (CE)
Rated current 63Amp



Feed unit	Interlink		Interlink		Tap-off units		Tap-off units		Tap-off units		Tap-off units	
Female	Length	1.2m	Length	2.4m	Unfused 32Amp	Fused 13Amp	Unfused 32Amp	Fused 13Amp	Unfused 32Amp	Fused 13Amp	Unfused 32Amp	Fused 13Amp
Pack 1	Pack 1		Pack 1		Length 3m	Length 3m	Length 5m	Length 5m	Length 5m	Length 5m	Length 5m	Length 5m
					Pack 1	Pack 1	Pack 1	Pack 1	Pack 1	Pack 1	Pack 1	Pack 1
												
UN3100	UN5102		UN5104		UN7113	UN7123	UN7115	UN7125				
UN3200	UN5202		UN5204		UN7213	UN7223	UN7215	UN7225				

Other configurations of tap-off units including fuse options are available on request.

All tap-off units comply with 17th Edition Wiring Regulations Section 543 (High Integrity Earthing).

Powertrack – run length component chart

To determine the number and size of track required for a given area, select your total run length (in metres) from the left hand column, then find the correct track combinations along that row.

Total run in metres	Track lengths required			
3.6	3.6			
4.2	1.8	2.4		
4.8	2.4	2.4		
5.4	3.6	1.8		
6.0	3.6	2.4		
6.6	2.4	2.4	1.8	
7.2	3.6	3.6		
7.8	3.6	2.4	1.8	
8.4	3.6	3.6	1.2	
9.0	3.6	3.6	1.8	
9.6	3.6	3.6	2.4	
10.2	3.6	3.6	1.8	1.2
10.8	3.6	3.6	3.6	
11.4	3.6	3.6	2.4	1.8
12.0	3.6	3.6	3.6	1.2

Total run in metres	Track lengths required					
12.6	3.6	3.6	3.6	1.8		
13.2	3.6	3.6	3.6	2.4		
13.8	3.6	3.6	3.6	1.8	1.2	
14.4	3.6	3.6	3.6	3.6		
15.0	3.6	3.6	3.6	2.4	1.8	
15.6	3.6	3.6	3.6	3.6	1.2	
16.2	3.6	3.6	3.6	3.6	1.8	
16.8	3.6	3.6	3.6	3.6	2.4	
17.4	3.6	3.6	3.6	3.6	1.8	1.2
18.0	3.6	3.6	3.6	3.6	3.6	
18.6	3.6	3.6	3.6	3.6	2.4	1.8
19.2	3.6	3.6	3.6	3.6	3.6	1.2
19.8	3.6	3.6	3.6	3.6	3.6	1.8
20.4	3.6	3.6	3.6	3.6	3.6	2.4

08 | Raised floor boxes and grommets

A high quality range of raised floor boxes to provide power and data to desks within the modern office environment. Available as standard or heavy duty versions, boxes are supplied with dividers for quick and easy configuration as either a 3 or 4 compartment box.

Designed with quality in mind, the standard support plate is 3mm thick and allows for high traffic levels. In the case of very heavy traffic a robust steel sub-frame can be used to support the lid. The sub-frame doesn't restrict space for wiring and accessories and also allows for fine adjustments to be made to accommodate uneven flooring.



Standard finish
GY
GY: Grey RAL7011 (floor box trim)

Designed and manufactured to
 BS EN 61534-22:2009
 BS EN 60670-1:2005
 BS EN 60670-23:2008
 BS EN 50085-1:2005
 BS EN 50085-2-2:2008



Barrel lock option for extra security



Optional steel sub-frame



Snap-in retainer guides



Reversible & self closing lid

Dividers to create 3 or 4 compartment options

Matching galvanised steel accessory plates

MT32 pre-wired option



Product information

- Standard depth 83mm
- Supplied with dividers to create 3 or 4 compartment box
- Two earth fixing points for flexible positioning of sockets
- 3mm thick medium load plate
- Steel sub-frame option for heavy traffic and fine adjustment to allow for uneven flooring
- Supplied with two snap-in cable retainers/guides
- Grey trim as standard
- Cut-out within lid for carpet or carpet tiles up to 6mm
- Reversible lid
- Supplied with metal screws to attach trim to box for a secure fix
- Fixings are pre-punched for quick and easy installation
- Barrel lock option available for extra security
- RCD option
- Self closing lid for extra safety and security
- Pre-wired option available with MT32 Connectors
- Heavy duty steel galvanized conduit (BS EN 61386-23:2004+A11:2010)

Raised Floor Boxes

Other options

- Steel lid & trim option for even greater strength and durability
- Lid available separately
- Replacement cable flap available separately
- Replacement screw pack available separately



3 compartment standard floor box (terminal) 357 x 257 x 83mm

code	description	pack
UM1010	1 x 2 gang Std	1
UM1020	2 x 2 gang Std	1
UM1030	3 x 2 gang Std	1
UM1110	1 x 2 gang CE	1
UM1120	2 x 2 gang CE	1
UM1130	3 x 2 gang CE	1



3 Compartment standard floor box (through) 357 x 257 x 83mm

code	description	pack
UM5210	1 x 2 gang Std	1
UM5220	2 x 2 gang Std	1
UM5230	3 x 2 gang Std	1
UM5211	1 x 2 gang CE	1
UM5221	2 x 2 gang CE	1
UM5231	3 x 2 gang CE	1



4 compartment standard floor box (terminal) 357 x 257 x 83mm

code	description	pack
UM5010	1 x 2 gang Std	1
UM5020	2 x 2 gang Std	1
UM5030	3 x 2 gang Std	1
UM5110	1 x 2 gang CE	1
UM5120	2 x 2 gang CE	1
UM5130	3 x 2 gang CE	1



4 Compartment standard floor box (through) 357 x 257 x 83mm

code	description	pack
UM5610	1 x 2 gang Std	1
UM5620	2 x 2 gang Std	1
UM5630	3 x 2 gang Std	1
UM5611	1 x 2 gang CE	1
UM5621	2 x 2 gang CE	1
UM5631	3 x 2 gang CE	1



Tap-off (Standard)
• To MT32 connector

code	length	rating	pack
UN8113	3m	32Amp unfused	1
UN8115	5m	32Amp unfused	1
UN8123	3m	13Amp fused	1
UN8125	5m	13Amp fused	1



Tap-off (Clean Earth)
• To MT32 connector

code	length	rating	pack
UN8213	3m	32Amp unfused	1
UN8215	5m	32Amp unfused	1
UN8223	3m	13Amp fused	1
UN8225	5m	13Amp fused	1

MT32 Connectors

The description 'male' (white) and 'female' (black) does not refer to the connector pins but describes and identifies the moulded connector housings. For further information please contact our Technical Team on +44 (0)1424 856688.

10 | Raised floor boxes and grommets

Raised Floor Boxes



Empty floor box

code	description	pack
UM1000	Plastic lid & trim	1
UM1500	Steel lid & trim	1



Sub-frame assembly

code	description	pack
UMSF1		1



Lock kit

code	description	pack
UMLK1		1



Raised floor lid assembly

code	description	pack
UMLD1	Plastic	1
UMLD3	Steel	1



Replacement screw pack

code	description	pack
UMSC1		1



Replacement cable flaps pack

code	description	pack
UMCB1		1



**Slave unit (SU) 32Amp rating
100x100x55mm**

code	description	pack
UM6100	4 way Std	1
UM6101	4 way CE	1

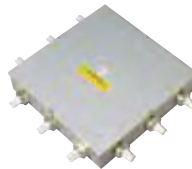

**Master distribution unit (MDU) 32Amp
rating 260 x 260 x 55mm**

code	description	pack
UM6200	9 way Std	1
UM6201	9 way CE	1



Floor grommet

code	description	pack
UTG1BK	without foam insert	1
UTG1GY	without foam insert	1



Floor grommet

code	description	pack
UTG2BK	with foam insert	1
UTG2GY	with foam insert	1



Floor power grommet

code	description	pack
UPG1BK	with foam insert	1
UPG1GY	with foam insert	1

Please note the floor box grommets are available in black BK (RAL9004) and grey GY (RAL7037).





13Amp 2 gang DP/TE switched socket

code	description	pack
UP651	3 comp	1
UP751	4 comp	1



13Amp 2 gang DP/TE switched socket clean earth

code	description	pack
UP653	3 comp	1
UP753	4 comp	1



Double plate with 2 x 13Amp 2 gang switched socket

code	description	pack
UP751D	4 comp	1
UP753D	4 comp CE	1

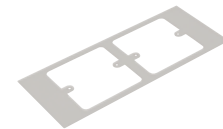

Plate to accept 2 x 1 gang accessory (M3.5 x 60.3mm)

code	description	pack
UP633	3 comp	1



Plate to accept 1 x 2 gang accessory (M3.5 x 120.3mm)

code	description	pack
UP632	3 comp	1



Plate to accept 1 x 1 gang accessory

code	description	pack
UP631	3 comp	1



Plate to accept 1 x 1 gang accessory

code	description	pack
UP731	4 comp	1

Plate dimensions
3 compartment = 185 x 95mm
4 compartment = 185 x 71mm
Plate material
Plates are manufactured from plain galvanised steel to match floor boxes.

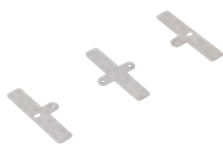

Plate to accept 2 x 1 gang accessory (M3.5 x 60.3mm)

code	description	pack
UP733*	4 comp	1

*Accessory overlaps adjacent plates

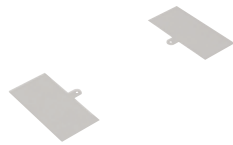

Plate to accept 1 x 2 gang accessory (M3.5 x 120.3mm)

code	description	pack
UP732*	4 comp	1

*Accessory overlaps adjacent plates



13Amp 2 gang RCD unswitched socket

code	description	pack
UP660	3 comp Std	1
UP663	3 comp CE	1



Data wave plate 4 x RJ45

code	description	pack
UP617	3 comp	1



Data wave plate 2 x RJ45

code	description	pack
UP717	4 comp	1

NEW



Blank plate

code	description	pack
UP621	3 comp	1
UP721	4 comp	1



Euro plate 2 gang

code	description	pack
UP615	3 comp	1

*Adaptor plate required
Note: Adaptor plates are not supplied by Marshall-Tufflex

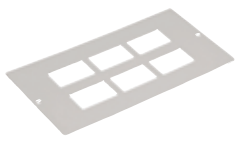

Data/voice plate 6 x RJ45

code	description	pack
UP612	3 comp	1
UP712	4 comp	1



Data/voice plate 4 x RJ45

code	description	pack
UP610	3 comp	1
UP710	4 comp	1

International accessory plates

It is advisable to use MTOP plates for conversion to a range of continental sockets. Please refer to page 234 of the main catalogue for more information.



12 | In-screed flooring systems

A range of floor outlet boxes, fittings and plates in galvanised steel, with choice of PVC-U or steel ducting

Product information

- 3 and 4 compartments (boxes come with extra divider to make 4 compartments)
- Suitable for 65-85mm screed depth
- Boxes for deeper floor screed available on request
- Box tray lid suitable for standard 6mm floor finishes
- For advice on box tray lids for non-standard floor finishes please contact our Technical Team
- Adjustable for box trim height
- Grey moulded carpet trim for floor outlet boxes
- Steel trims with various finishes available
- Universal junction box with integral, fully-reversible cable segregation

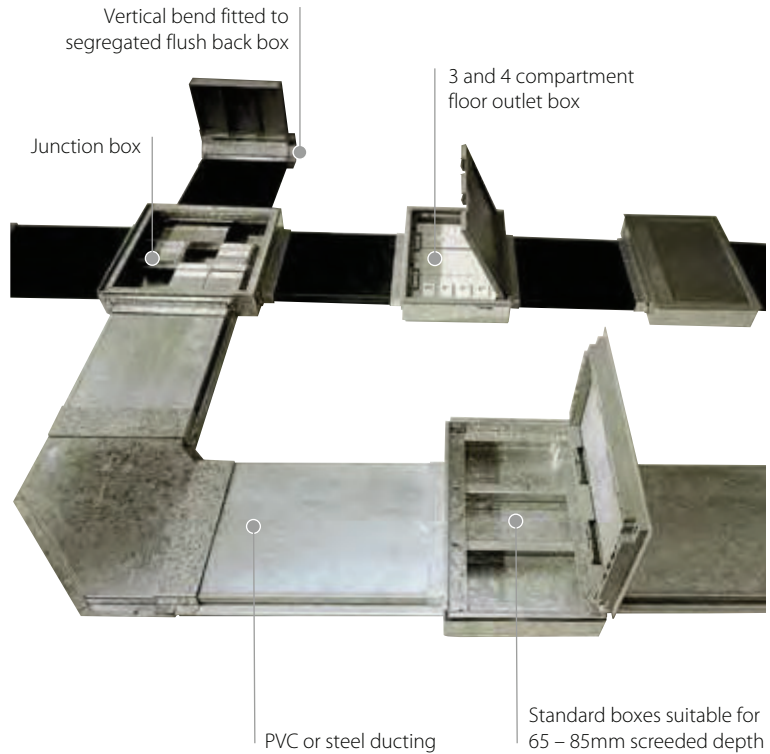

Standard floor box trim
GY
GY: Grey RAL7011 (floor box trim)

Other trim finishes: Floor boxes can be provided with a variety of trim finishes such as brass, stainless steel and painted colours. For further information please contact the Technical Team on +44 (0)1424 856688.

Basic components



**Floor outlet box
3 and 4 compartment**

code	size	pack
USF32	357 x 257mm	1



Floor box lid assembly

code	description	pack
UMLD1	Plastic	1
UMLD3	Steel	1

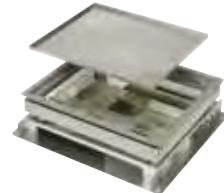

**Universal junction box
(excluding adaptors)**

code	size	pack
USJ3	269 x 234mm	1



**Twin section PVC-U duct
(three ducts required per run)**

code	size	pack
MTU125	75 x 25mm	8 x 3m

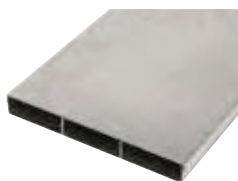

3 Compartment steel duct

code	description	pack
USFT25	225 x 25mm	1 x 2.5m



Blank end

code	description	pack
USFB1	3 x 20mm KO	1
USFB25	3 x 25mm KO	1



Adaptor

code	pack
USFA1	1



Connector

code	pack
USFC1	1

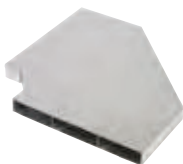

**Flat bend
(excluding connector)**

code	description	pack
USFF1	steel	1
HFP125BK	PVC-U	1



**Vertical bend
(excluding connector)**

code	description	pack
USFV1	steel	1
HVP125BK	PVC-U	1



Steel screeding plate

code	pack
USFSP1	1

Note: Used in place of box lid when screeding

Floor materials

Marshall-Tufflex can supply floor outlet boxes and junction boxes that are suitable for different floor materials, such as marble, stone or wood, or where a higher IP rating is required. For more information on these, please contact our Technical Team on +44 (0)1424 856688.





13Amp 2 gang DP/TE switched socket

code	description	pack
UP651	3 comp	1
UP751	4 comp	1



13Amp 2 gang DP/TE switched socket clean earth

code	description	pack
UP653	3 comp	1
UP753	4 comp	1



Double plate with 2 x 13Amp 2 gang switched socket

code	description	pack
UP751D	4 comp	1
UP753D	4 comp CE	1

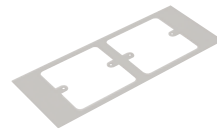

Plate to accept 2 x 1 gang accessory (M3.5 x 60.3mm)

code	description	pack
UP633	3 comp	1

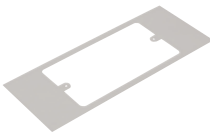

Plate to accept 1 x 2 gang accessory (M3.5 x 120.3mm)

code	description	pack
UP632	3 comp	1



Plate to accept 1 x 1 gang accessory

code	description	pack
UP631	4 comp	1



Plate to accept 1 x 1 gang accessory

code	description	pack
UP731	4 comp	1

Plate dimensions

3 compartment = 185 x 95mm
4 compartment = 185 x 71mm

Plate material

Plates are manufactured from plain galvanised steel to match floor boxes.

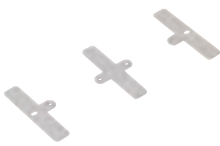

Plate to accept 2 x 1 gang accessory (M3.5 x 60.3mm)

code	description	pack
UP733*	4 comp	1

*Accessory overlaps adjacent plates

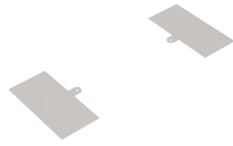

Plate to accept 1 x 2 gang accessory (M3.5 x 120.3mm)

code	description	pack
UP732*	4 comp	1

*Accessory overlaps adjacent plates



13Amp 2 gang RCD unswitched socket

code	description	pack
UP660	3 comp Std	1
UP663	3 comp CE	1



Blank plate

code	description	pack
UP621	3 comp	1
UP721	4 comp	1



Euro plate 2 gang

code	description	pack
UP615	3 comp	1

*Adaptor plate required
Note: Adaptor plates are not supplied by Marshall-Tufflex

International accessory plates

It is advisable to use MTOP plates for conversion to a range of continental sockets. Please refer to page 234 of the main catalogue for more information.



Data/voice plate 6 x RJ45

code	description	pack
UP612	3 comp	1
UP712	4 comp	1



Data/voice plate 4 x RJ45

code	description	pack
UP610	3 comp	1
UP710	4 comp	1



Data wave plate 4 x RJ45

code	description	pack
UP617	3 comp	1



Data wave plate 2 x RJ45

code	description	pack
UP717	4 comp	1

NEW

14 | MT32 pre-wired underfloor distribution

MT32 pre-wired underfloor distribution is a prefabricated wiring system that incorporates 32Amp plug and play connector technology. The system provides a range of pre-wired, pre-tested products which can be used alone or in conjunction with powertrack, desk modules and other pre-wired systems to accommodate various underfloor layout options.



Product information

- Distribution from powertrack supply
- 32Amp power distribution
- Standard and CE systems
- Greater scope in layout design
- Wider range of floor distribution
- Economical and practical for large or high density floor areas
- Designs, dimensions and cable capacities to meet the latest BS EN ISO standards and accommodate all building designs and construction parameters
- Accessory plates manufactured from galvanised steel to match floor boxes

Plate dimensions

- 3 compartment 185 x 95mm
- 4 compartment 185 x 71mm



Standard finish
GY
GY: Grey RAL7011 (floor box trim)

MT32 Connectors
The description 'male' (white) and 'female' (black) does not refer to the connector pins but describes and identifies the moulded connector housing. For further information please contact our Technical Team on +44 (0)1424 856688.

Components



Slave unit (SU)
32Amp rating
100 x 100 x 55mm

code	description	pack
UM6100	4 way Std	1
UM6101	4 way CE	1

MT32 Four compartment floor boxes

Terminal: Refer to page 9



Floor box – through 3 compartment
357 x 257 x 83mm

code	description	pack
UM5210	1 x 2 gang Std	1
UM5220	2 x 2 gang Std	1
UM5230	3 x 2 gang Std	1
UM5211	1 x 2 gang CE	1
UM5221	2 x 2 gang CE	1
UM5231	3 x 2 gang CE	1



Floor box – terminal 3 compartment
357 x 257 x 83mm

code	description	pack
UM1010	1 x 2 gang Std	1
UM1020	2 x 2 gang Std	1
UM1030	3 x 2 gang Std	1
UM1110	1 x 2 gang CE	1
UM1120	2 x 2 gang CE	1
UM1130	3 x 2 gang CE	1



Interconnecting conduit assembly
To MDU, SU, FBDU and floor boxes

code	length	description	pack
UC3353	3m	Std	1
UC3355	5m	Std	1
UC4453	3m	CE	1
UC4455	5m	CE	1



***Male & female adaptors 220mm tail**
- fits 20mm knockout

code	description	pack
UA7234	3 pole (male)	1
UA7244	4 pole (male)	1
UA7134	3 pole (female)	1
UA7144	4 pole (female)	1

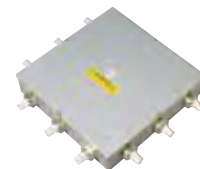

Master distribution unit (MDU) 32Amp
rating 260 x 260 x 55mm

code	description	pack
UM6200	9 way Std	1
UM6201	9 way CE	1

*For adapting additional equipment and floor boxes to modular system.





13Amp 2 gang DP/TE switched socket

code	description	pack
UP651	3 comp	1
UP751	4 comp	1



13Amp 2 gang DP/TE switched socket clean earth

code	description	pack
UP653	3 comp	1
UP753	4 comp	1

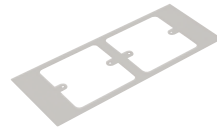

Plate to accept 2 x 1 gang accessory (M3.5 x 60.3mm)

code	description	pack
UP633	3 comp	1

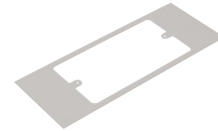

Plate to accept 1 x 2 gang accessory (M3.5 x 120.3mm)

code	description	pack
UP632	3 comp	1



Plate to accept 1 x 1 gang accessory

code	description	pack
UP631	3 comp	1



Plate to accept 1 x 1 gang accessory

code	description	pack
UP731	4 comp	1

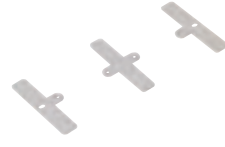

Plate to accept 2 x 1 gang accessory (M3.5 x 60.3mm)

code	description	pack
UP733*	4 comp	1

*Accessory overlaps adjacent plates



Plate to accept 1 x 2 gang accessory (M3.5 x 120.3mm)

code	description	pack
UP732*	4 comp	1

*Accessory overlaps adjacent plates



13Amp 2 gang RCD unswitched socket

code	description	pack
UP660	3 comp Std	1
UP663	3 comp CE	1



Data wave plate 4 x RJ45

code	description	pack
UP617	3 comp	1



Data wave plate 2 x RJ45

code	description	pack
UP717	4 comp	1

NEW



Blank plate

code	description	pack
UP621	3 comp	1
UP721	4 comp	1



Data/voice plate 6 x RJ45

code	description	pack
UP612	3 comp	1



Data/voice plate 4 x RJ45

code	description	pack
UP610	3 comp	1
UP710	4 comp	1



Euro plate 2 gang

code	description	pack
UP615	3 comp	1

*Adaptor plate required
Note: Adaptor plates are not supplied by Marshall-Tufflex



Double plate with 2 x 13Amp 2 gang switched socket

code	description	pack
UP751D	4 comp	1
UP753D	4 comp CE	1

Plate dimensions
3 compartment = 185 x 95mm 4 compartment = 185 x 71mm
Plate material
Plates are manufactured from plain galvanised steel to match floor boxes.

Suggested Layout

Should powertrack be the preferred method of underfloor power supply, then combining powertrack with MT32's interlinked through floor boxes and/or slave units will provide a far greater reach of floor area than can be achieved using powertrack alone.

Powertrack tap off

- 32Amp tap-off pre-wired to MT32 male connector
- 3.0m and 5.0m leads, Standard or CE
- Also 13Amp fused tap-offs

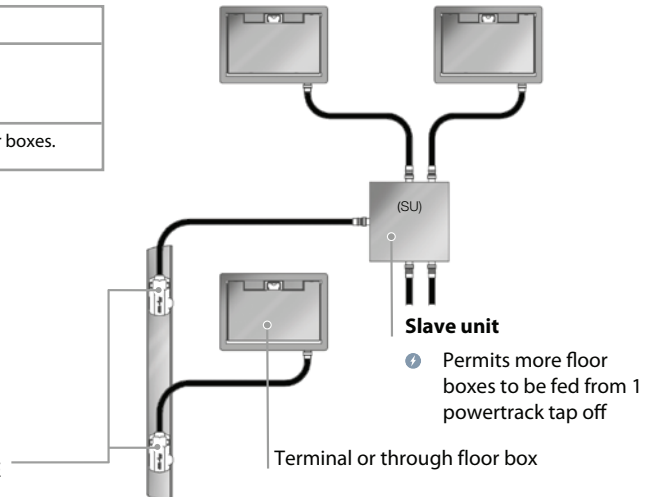

16 | Desk surface modules

A range of surface mounted power and data modules for use with office furniture.

Product information

- Flip up units - flush finish when in use
- Surface units - desk mounted
- Desk grommets
- Fed from wall trunking or floor boxes
- Various switching and fusing options available
- Individual 3.15Amp fuses
- Master switch option
- RCD and MCB protection available



Various configurations of power and data outlets

Aluminium body

Surface units

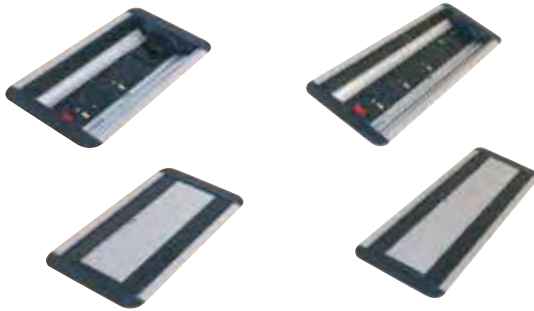

Flip-up unit with master switch and individually fused sockets

code	description	pack
FDMF002BK	2 gang	1
FDMF007BK	4 gang	1
FDMF008BK	5 gang	1

Flip-up unit with master switch, data outlets and individually fused sockets

code	description	pack
FDMF013BK	2 gang + 1 Cat 5e	1
FDMF014BK	3 gang + 2 Cat 5e	1
FDMF015BK	4 gang + 2 Cat 5e	1



Curved surface unit with master switch and individually fused sockets

code	description	pack
FDMC003BK	2 gang	1
FDMC005BK	3 gang	1
FDMC009BK	4 gang	1
FDMC011BK	6 gang	1

Please note this product comes with 2 x 13-40mm thick desk clamps



Curved surface unit with master switch, data outlets and individually fused sockets

code	description	pack
FDMC012BK	2 gang + 1 Cat 5e	1
FDMC013BK	3 gang + 2 Cat 5e	1
FDMC014BK	4 gang + 2 Cat 5e	1
FDMC015BK	4 gang + 4 Cat 5e	1
FDMC016BK	6 gang + 4 Cat 5e	1



13Amp in-feed power cable Wieland connector

code	length	pack
DM8301	1m	1
DM8302	2m	1
DM8303	3m	1



Desk grommet

code	diameter	pack
DG1BK	92mm	1



Desk clamp (For use with curved units only)

code	size	pack
DCL1BK	15-30mm	1
DCL2BK	25-30mm	1

A range of power and data modules ideal for under desk mounting.



Product information

- High strength, fire retardant polycarbonate moulded modules
- Aluminium RCBO units
- The system can be fed directly from underfloor busbar through a floor grommet to an RCBO unit to then feed single or multiple modules as required
- Can be fed from wall trunking, floor boxes, grommets or powerpoles
- For single use or modules can be interlinked
- In-feed supply either by Wieland GST 18/3 connection or plug socket
- Unswitched individually fused 3.15Amp or 5Amp sockets
- 2 and 4 gang options plus the ability to link modules
- Twin USB points charge up to 5 x faster than your standard PC USB port
- Desk units comply with BS 6396 for Electrical Systems in Office Furniture when powered from a plug socket outlet and with BS 7671 when powered from a power distribution network.
- RJ45 data sockets in Cat 5e, Cat 6 or blank configuration options
- All our sockets are ASTA certified

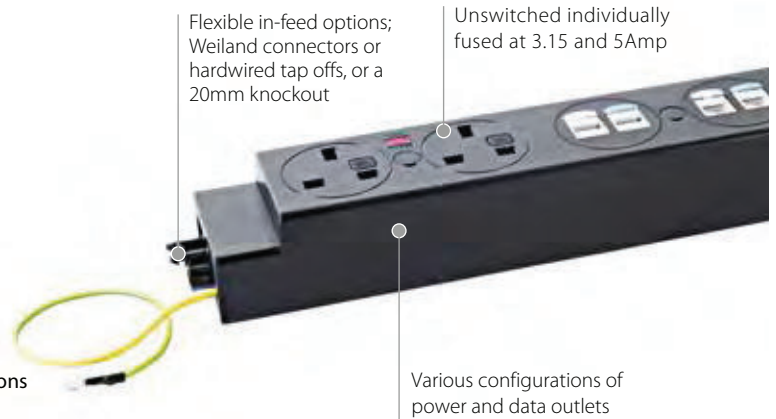

Our range of power modules and RCBOs can be integrated to deliver a complete system from underfloor to desk.

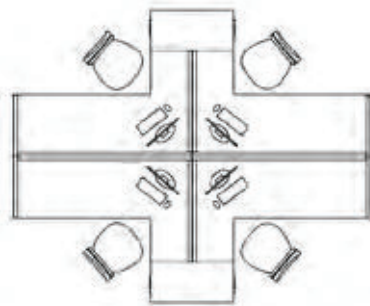
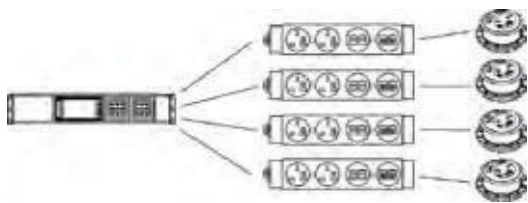

Power modules



Power module 2G indv fused		
code	description	pack
DM5001	3.15Amp	1
DM5003	5Amp	1



Power module 4G indv fused		
code	description	pack
DM5002	3.15Amp	1
DM5004	5Amp	1

Power & data modules



Module 2xpower 2xUSB 2xCat 5e		
code	description	pack
DM5030	3.15Amp	1
DM5033	5Amp	1



Module 2xpower 2xUSB 2xCat 6		
code	description	pack
DM5031	3.15Amp	1
DM5034	5Amp	1



Module 2xpower 2xUSB 2xblank		
code	description	pack
DM5032	3.15Amp	1
DM5035	5Amp	1



RCBO 16A/30mA



RCBO 1xGST18 F & tap-off STD

code	length	pack
DM5050	3m	1
DM5051	5m	1



RCBO 1xGST18 F & tap-off CE

code	length	pack
DM5052	3m	1
DM5053	5m	1



RCBO 4xGST18 F & tap-off STD

code	length	pack
DM5054	3m	1
DM5055	5m	1



RCBO 4xGST18 F & tap-off CE

code	length	pack
DM5056	3m	1
DM5057	5m	1



RCBO 1xGST18 F

code	pack
DM5058	1



RCBO 4xGST18 F

code	pack
DM5059	1

Both modules supplied with 20mm knockout for power input

Wieland power cables



GST18/3 F & 13A plug

code	length	pack
DM8301	1m	1
DM8302	2m	1
DM8303	3m	1



GST18/3 M/F lead

code	length	pack
DM8502	1m	1
DM8503	1.5m	1
DM8504	3m	1

Desk Module USB

Power and Data Modules with Twin USB Fast Charger

With 5Amp output across two USB ports, our Power and Data Modules can simultaneously charge two devices at speeds comparable to, or faster than, the devices' own chargers.

- Fast charge 2 devices
- 5 Amps combined maximum output
- Up to 91% efficiency
- 5000+ USB insertion connections



The USB ports are designed to withstand the elements of a commercial environment with connectors built to withstanding over 5000 insertions.

This feature allows you to charge your devices faster, with far less power wastage through heat generation, and comply with the latest international standards on the efficiency of power supplies.

For more information on our compact power and data modules turn to page 17.

MT32 Pre-wired underfloor power distribution

Singles Cabling System

Extension, Connection, Adaptor and Terminal Cables

Cable Type	6491B (HO1Z-R) to BS 7211 (LSOH)
Size	4.0mm ² x 3 (PE) or 4.00mm ² x 4 (CE)
Connector Self Lock Retention	> 80N
Male/Female Connector Diameter	19.2mm
Terminal Block	6 x 4.0mm ²
Adaptor (4.0mm ²)	20mm

Underfloor Distribution System

Conduit Assembly, Tap Off and Adaptor

Cable Type	6491X (BASEC BS6004 H07V-R)
Protective Earth (P.E)	4.0mm ² x 3 (Grey Plug)
Clean Earth (C.E)	4.0mm ² x 4 (Red Plug)
Protection: Conduit Assembly	25mm Steel flexible conduit (>1KN Tensile Load to BS EN 61386-23)
Protection: Tap Off	20mm Steel flexible conduit (>1KN Tensile Load to BS EN 61386-23)

General Specification

Approvals: System	Designed to comply with BS 7671:2008 IEE Wiring Regulations
Approvals: Connector	Designed to comply with EN 61535:2009 (Fixed installation couplers for permanent connection)
Normal Voltage	250 volts
Frequency	50/60 Hertz
Volt Drop Line & Neutral Connector	1.0 mV/A/M
Volt Drop Line & Neutral (Flexible Cabling System) 2.5mm	19.0 mV/A/M
Volt Drop Line & Neutral (Underfloor) 4.0mm	12.0 mV/A/M
Connector Impedance	1.0m Ω/connector
Connector, Body Material	PA66 – GF25
Connector Colour Female	Black
Connector Colour Male	White
Compatibility	Keyed against incorrect insertion
Operating Temperature (Ambient)	-5 °C to + 40 °C
Safety	PE contact engages first
Degree of Protection	Engaged IP2XC

Installation**MT32 pre-wired socket range****Fitting**

- Plug in incoming pre-wired lead (from previous socket or distribution board) to appropriate connector mounted in socket assembly box.
- Connect selected pre-wired lead to outgoing connector mounted on opposite side of socket assembly box.
- Clip complete assembly into trunking compartment.
- When trunking cover is fitted, it should be slid between back box frame and the loosened accessory face plate.
- Front plate is then fully tightened down to clamp accessory in place.
- For pre-made close coupled assemblies, use lid spacer (ES1WH) between boxes.

MT32 system with non-Marshall-Tufflex socket assemblies**Fitting**

- For non-Marshall-Tufflex accessories, use pre-assembled outlet box unit.
- Connect cable tails to accessory in accordance with wiring regulations and fit accessory to back box.
- Connect pre-wired incoming and outgoing leads and fit to trunking (as above).
- For close coupled assemblies, use lid spacer (ES1WH) between boxes.

Earthing requirements for the installation of equipment having High Protective/Conductor currents. BS 7671: 2008 Reg. 543.7

The scope of Reg. 543.7.1.203 requires that every final circuit intended to supply one or more items of equipment, where the total protective conductor current is likely to exceed 10mA. in normal use, shall have a high integrity protective connection.

Singles Cabling System 4.0mm² Final Circuit

MT32 singles systems conform to the high integrity protective requirement by virtue of having a single copper protective conductor of 4mm², (Reg 543.7.1.203) with the protective conductor being enclosed throughout in trunking or flexible conduit to provide additional protection against mechanical damage.

Note: Different key ways apply between 2.5mm² and 4.0mm²

p14

Product Information

Powertrack

Powertrack is an underfloor busbar system rated at 63Amp maximum. It is available in Standard or CE (Clean Earth) versions.

Lengths

- Powertrack lengths of 1.2m, 1.8m, 2.4m and 3.6m with tap-off outlets at 300mm

Safety

- Snap-fit feed units, couplers and tap-offs are key and colour-coded to avoid assembly errors.

Installation

- Lay out track lengths and feed unit as required to suit final assembly
- Position and secure the feed unit in place
- Carefully engage the first track length on to the feed unit socket
- Ensure the clip action is secure at the coupler and unit feed also that alignment is correct in laying the track length to the floor
- Secure the track length in place along its length at recommended spacing shown below using the brackets provided
- Additional track lengths can now be placed as below.
- Ensure the assembly is secure and prepare to make electrical connections

Please refer to the full installation instructions, EL182 available at www.marshall-tufflex.com or by contacting the Technical Team on +44 (0)1424 856688.



Standard = grey



CE = red

- A shutter is operated on insertion to prevent accidental contact.
- Avoid exceeding the maximum power rating of the track. This is ascertained by the maximum power requirement for each floor outlet box

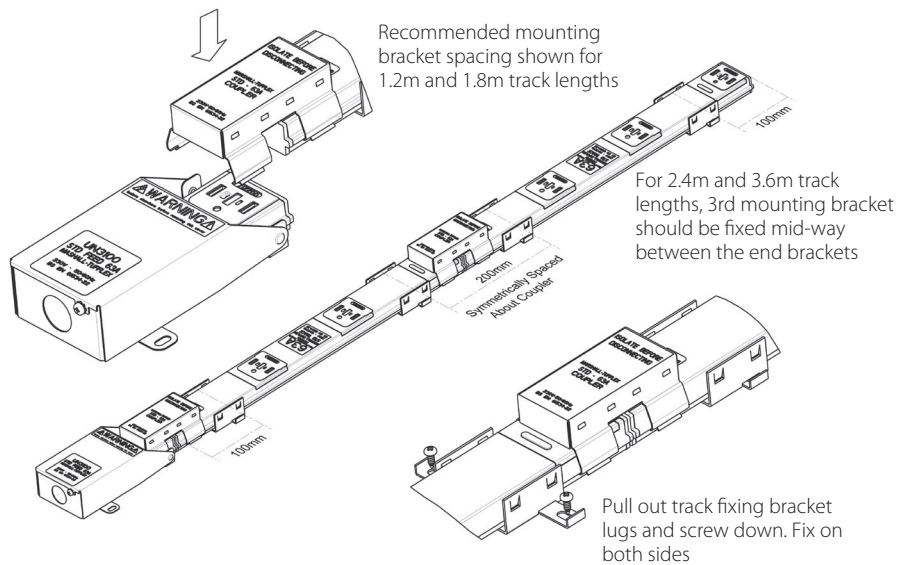

Positioning

- For the most economic format, it is advised that Powertrack is arranged in parallel runs with powertrack feed units orientated to the incoming supply.
- For optimum layout flexibility, spacing should be a maximum of 5.5m between each length of track and 2.5m from the perimeter when using a standard 3m tap-off to a floor box.

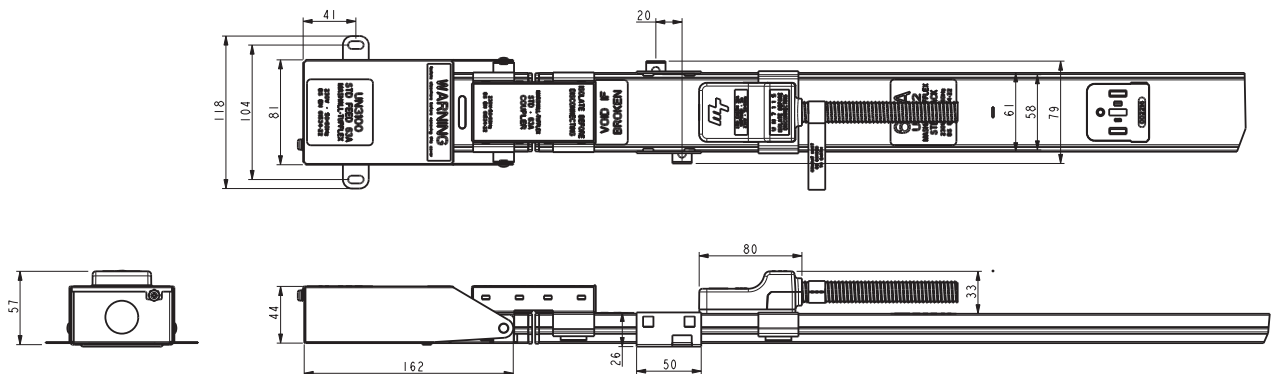

Electrical Characteristics			
Rated Current		63	Amps
Rated Voltage		230	Volts
Frequency		50/60	Hz
Conditional Short Circuit Rating	(Protection device:BS1361 fuse)	16	KA
Conductor Resistance Line & Neutral		4.4	mΩ/m
Volt Drops Line & Neutral	Powertrack	4.4	mV/A/m
	Feed Unit + Coupler	2.2	mV/A
	Tap-Off	0.73	mV/A
	4mm ² Cable	11.0	mV/A/m
	Coupler	1.5	mV/A
	Interlink Unit	4.5	mV/A
	16mm ² Cable (1.2m)	3.9	mV/A/m
Earth Fault Loop Impedance:	Line to Earth (Casing)	2.8	mΩ/m
	Line to Earth (Conductor)	3.2	mΩ/m
	Line to Earth (Conductor + Casing)	2.8	mΩ/m
	Feed Unit + Coupler	2.2	mΩ
	Tap-Off	0.73	mΩ
	4mm ² Cable	11.0	mΩ/m
	Coupler	1.5	mΩ
	Interlink Unit	4.5	mΩ
	16mm ² Cable	3.9	mΩ/m
Mechanical Data			
Number of Copper Conductors		2 or 3	
Conductor Cross-section Area	Nominal	20	mm ²
Powertrack Casing Copper Equivalent	(Where casing is protective Earth)	12	mm ²
Cable Termination Capacity		16	mm ²
Tap-Off Cable 32A		4.0	mm ²
Tap-Off Cable 13A or 16A		4.0	mm ²
Tap-Off Conduit Sizes	Rating: Heavy duty conduit <1KN Tensile Load to BS EN 61386-23	Ø20	mm
Flexible Interlink Cable		16	mm ²
Flexible Interlink Conduit	Rating: Heavy duty conduit <1KN Tensile Load to BS EN 61386-23	Ø25	mm
Feed Conduit Entry		1 x Ø25	mm
IP Rating		40	
Minimum void depth (track + tap-off)		59	mm
Materials specification			
Powertrack Casing	Galvanised Steel		
Conductors	High Conductivity Copper/brass		
Powertrack Insulators	PBT		
Sockets/Tap-Off Plug/Joint Mouldings	Polycarbonate		
Shutter	PBT		
Tap-Off/Interlink Flexible Conduit	Galvanised Steel		
Tap-Off Cable	BASEC BS6004 H07V-R		
Tap-Off/Coupler Blade	Copper		
Feed Unit Case	Galvanised Steel		
Flexible Interlink Cable	BASEC BS6004 H07V-R		
Feed/Flexible Interlink Housing	Galvanised Steel		

Technical Specifications

Third party certified and tested to comply with:
 BS EN 61534-1: 2011
 BS EN 61534-22: 2009
 BS 5733: 1995 where applicable.
 Marshall-Tufflex is registered by BSI to BS EN ISO9001: 2008
 MT Powertrack is designed to comply with the requirements of BS 7671: 2008 (IEE Wiring Regulations).

ASTA Type Test Certification
 Powertrack is independently tested by Intertek to BS EN 61534-22:2009 clauses 15.4,18.4.3.2, & 18.4.3.3

Regulation 543.7 Installations to BS 7671:2008 Earthing requirements for the installation of equipment having high protective/ conductor currents.

The scope of Reg. 543.7.1.203 requires that every final circuit intended to supply one or more items of equipment, where the total protective conductor current is likely to exceed 10mA. in normal use, shall have a high protective connection. All MT Powertrack tap-off units conform to the high integrity protective requirement by virtue of using a protective conductor of 4mm² enclosed within a flexible conduit, thus providing additional protection against mechanical damage. Regulation 543.7.1.203.

32Amp 3 metre tap-off unit

The 32Amp tap-off unit comprises of an unfused tap-off* a flexible metal conduit with integral 4mm² conductors. These units are designed to comply with regulation 434.2.1(i) of BS 7671:2008 by virtue of the following:

- 1 Maximum length of cable is <3 metres.
- 2 Minimum risk of faults as the item is factory assembled and fully tested.
- 3 Fully protected by flexible steel conduit located within raised access floor that offers further protection.

*Fused 3 metre tap-offs are available if required.

5 metre tap-off unit

Tap-off units in excess of 3 metres should only be used if they contain a fuse or the powertrack is protected by a 32Amp rated protective device.

Raised floor boxes

Three and four compartment boxes and a range of grommets that can be configured to meet client requirements for accessing multiple services concealed below a raised floor system.

Technical Specifications

Raised floor boxes are third party tested to comply with:

- BS EN 61534-22:2009
- BS EN 60670-1:2005
- BS EN 60670-23:2008
- BS EN 50085-1:2005
- BS EN 50085-2-2:2008

Material

- Lid/trim: flame retardant polypropylene grey RAL 7011
- Box assembly: galvanised steel
- Load plate: 3mm zinc plated steel
- Accessory plate: galvanised steel

Installation

- Box module has 20 and 25mm knockouts (pre-wired options available).
- Mounting plates:
3 compartment = 185 x 95mm
4 compartment = 185 x 71mm
- Standard accessory mounting plates available depending on suitability of floor box configuration.
- Cable covers protect cables when lid is closed.
- Detailed installation instructions are supplied in box.

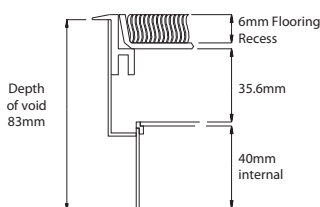

Dimensions

- For dimensions of non standard boxes and trims, contact Technical Hotline on +44 (0)1424 856688.

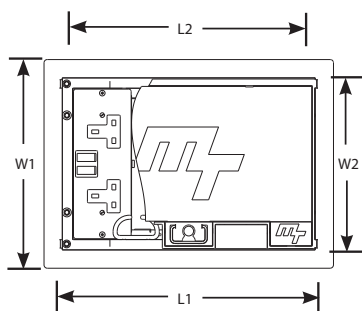

Dimensions

No of compartments	Nominal trim size (L1 x W1)	Cut out dimensions (L2 x W2)	Accessory Plate Dimensions
3	357 x 257mm	322 x 222mm	185 x 95mm
4	357 x 257mm	322 x 222mm	185 x 71mm
		General tolerance +3mm	

Care should be taken to ensure that box edges are smoothed and free from burrs. Carpet tile cut size for lid is 303 x 166mm

Load Testing

Load testing of floor boxes to:
BS EN 61534-22:2009
BS EN 50085-2-2:2008

The floor boxes have been tested to and comply with the loading requirements of the aforementioned standards.

There are two loading criteria for the floor boxes:

1. A point loading; to simulate foot traffic or light furniture like a chair leg / caster sitting on the lid. The maximum permissible deflection is 6mm (BS EN 61534-22:2009 and BS EN 50085-2-2:2008)
2. A plate loading; to simulate heavy foot traffic or larger furniture loads, the maximum permissible deflection is 4mm (BS EN 61534-22:2009) or 6mm (BS EN 50085-2-2:2008)

Note: The maximum permissible permanent deflection after the load has been removed is 3mm for both standards.

The loading graphs show the deflection based on floor boxes without and with a sub-frame. The point loading value is approaching ¼ of a metric tonne without sub-frame and reaching ¼ of a metric tonne with sub-frame. In both cases the permanent deflection is less than ¼ mm.

For plate loading without sub-frame the value is approaching ¼ of a metric tonne with 4mm deflection and ½ of a metric tonne with 6mm deflection. With the sub-frame fitted the loading reaches ¼ of a metric tonne with 4mm deflection and ½ a metric tonne with 6mm deflection. In both cases the permanent deflection is reaching 0.5mm.

Note: floor boxes fitted with sub-frame can exceed more than 1 metric tonne plate load before lid failure. In all tests (with and without sub-frame) the required loading was reached without damage to the plastic trim or compromised the lid.

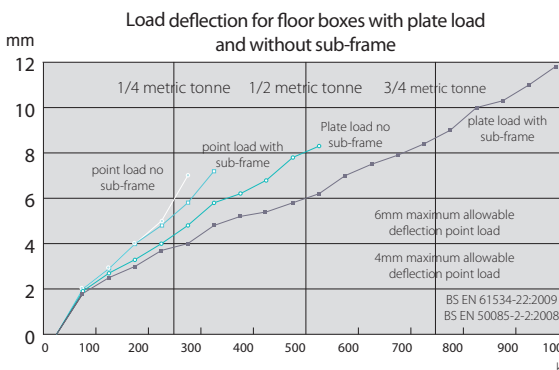
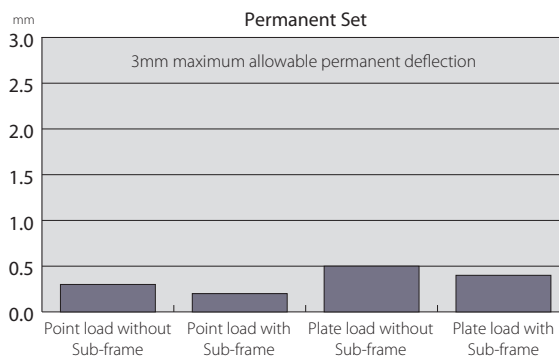

Grommets

Material

- ABS Flame retardant
- Flammability: UL94 V-O at 2.0mm
- Colour: polypropylene grey RAL 7011
- Lid: captive screwdown
- Lid recess: 15mm for extra strength
- Through power/data options

Dimensions

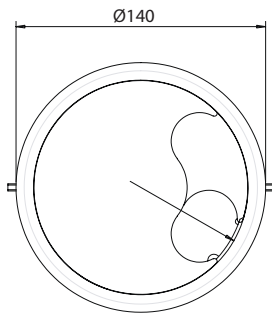

Cut out dimensions

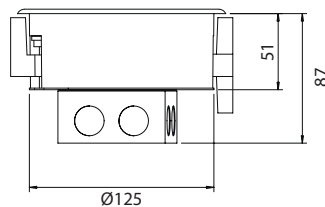

In-screed system

Three and four compartment boxes configured to meet client requirements for accessing multiple services concealed within an inscreed floor system.

Standard system is suitable for screed depths of 63mm to 85mm. For other screed depths please contact the Technical Team on +44 (0)1424 856688.

Material

- Lid/trim: polypropylene grey RAL 7011
- Frame assembly: galvanised steel
- Modular boxes: galvanised steel
- Load plate: galvanised steel

Installation

- Layout planning essential as alterations are not possible once screed is laid.
- Place floor boxes and junction boxes in position with top of boxes level and in line with expected finished floor level, with the sub-frame raised 10mm.
- Adjust boxes to screed depth by adjusting sub frame height.
- When boxes are in correct position, use PVC-U or steel duct to link between.
- To use conduit for linking boxes, utilize the Ø20mm knockout in the blank plate.
- Floor boxes can only be used as through boxes.

- Junction boxes have all round access with internal segregation.
- Duct adaptors and blank ends are not supplied for junction and service boxes. These must be ordered separately to individual requirements.
- Use a connector to join lengths of ducting.
- Flat and vertical bends or junction boxes are used where a change of direction is required.
- An optional steel screeding plate (USFSP1) is available to replace the box lid temporarily when screeding the floor.

Wiring accessories and mounting plates

- 3 compartment box: 185 x 95mm
- 4 compartment box: 185 x 71mm
- For use with standard 60.3mm and 120.6mm accessories with blank or pre-punched plates for data/telecoms etc.

Desk units

Flip up units

- Units have bi-directional access and are suitable for installation to BS 6396.
- Up to 4 x individually fused 3.15 sockets.
- Up to 4 x data outlets.

Fitting

- Simple, secure ratchet with hidden screw fixing.

Desk cut out size

- 132 x 430mm.
- Unit casing depth 90mm from top surface of desk.
- It is recommended that at least 400mm is clear below the cut out to allow cables to move freely.
- Cut out width is constant (132mm).
- Cut out length (430mm) will vary according to order requirements.

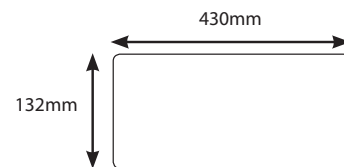

Junction box

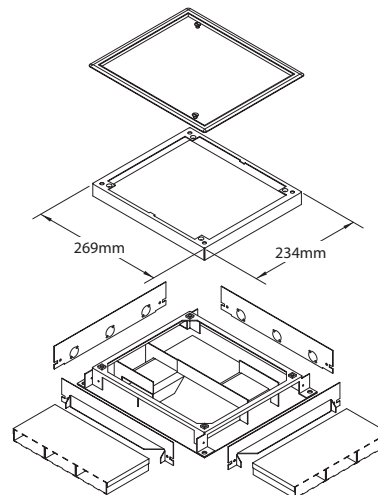

Floor outlet box

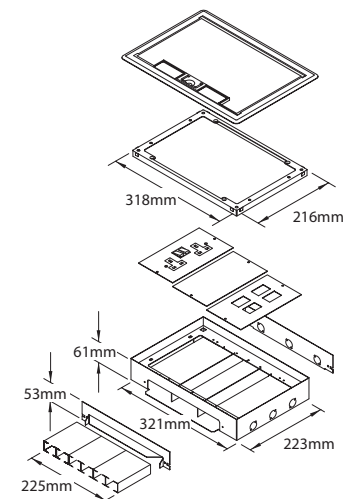

Box screed depth adjustment

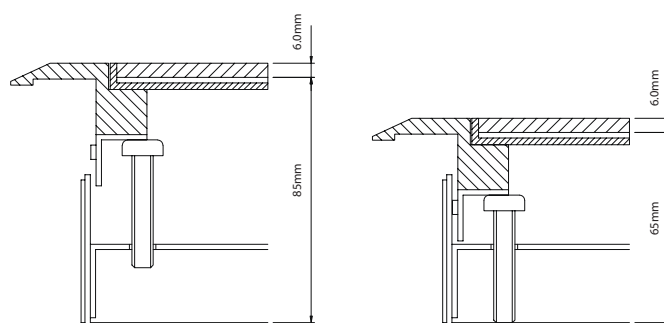

Desk grommets

Dimensions

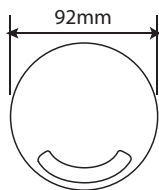

Cut out size

Box type	Diameter
DG1	80mm
General tolerance	2mm

Curved surface unit

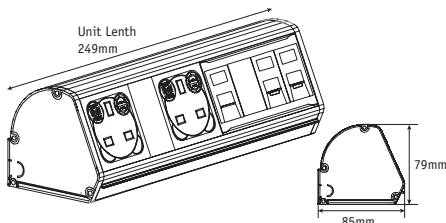

Adjustable desk clamp

Adjustable clamps suit desks from 5mm – 48mm thick.

- For use with curved surface units only.

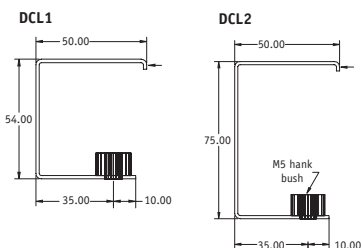

Power and Data Modules

Standards

BS 1363-1
 BS 1363-2 (where applicable)
 BS 5733:2010+A1:2014
 EN 50581:2012
 EN 301 489-34(2012)
 IEC 60884-1:2005
 For more information please contact our Technical Team on +44 (0)1424 856688.

Material

Power and Power and Data Modules are constructed from high strength flame retardant black polycarbonate mouldings. RCBO – constructed from aluminium casing

Insulation

Reinforced insulation

Earth Bonding:

- **Power Modules**
 An external earth terminal allows connection of earth bonding leads without dismantling the unit. Please use suitable tools to cut earth lead from Power Modules if required.
- **Power and Data Modules**
 Our Power and Data Modules units are supplied as standard with a prefitted 250mm earth lead to 5mm ring terminal.

Fusing

To enable compliance to BS6396 the UK sockets are fitted with Ø5 x 20mm anti-surge ceramic fuses, with colour-coded fuse clips to denote the rating (3.15Amp or 5Amp).

RCBO Rating

30mA 16Amp

Quality and Testing:

- 100% testing - continuity, polarity, insulation & earth
- **Power and Data Modules only**
 - USB charger: Output voltage and resistance
 - Data & AV: All sockets continuity tested

Dimensions

Power Modules

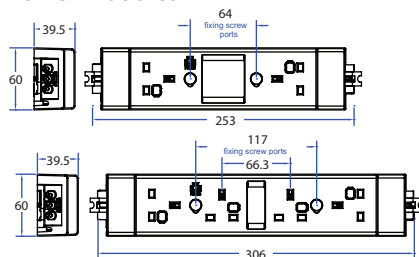

Power and Data Modules

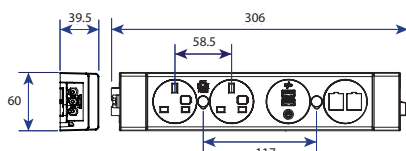

Configuration

- **Power modules**
 Power only
- **Power and data modules**
 2 x UK fused sockets plus 2 configurable gangs for Power, USB charging or data/AV
- **RCBOs**
 Designed to be connected directly to underfloor track.
 Input connections via tap-off.
 Output connection via Weiland GST18/3.

Connection options

Power and Data Modules - Built in GST18/3 male for power in, plus optional GST18/3 female connector for power out on certain configurations.

Two modules units can be securely clipped together via the inbuilt GST18/3 connectors e.g. a DM5001 and DM5030 (both with 3.15Amp fuses) can be joined to form a BS6396 compliant 6 socket unit.



The rear section of the Power and Data Modules can be removed for onsite data/AV installation.

Cable type

In-feed power cable shown with optional Wieland connector.

- 13Amp rating
- Specification of cable length is necessary

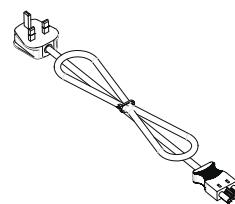

Power module earth lead

Size: 1.5mm²
 Length: 250mm with 5mm ring terminal.



Marshall-Tufflex
Churchfields Industrial Estate
Hastings East Sussex
TN38 9PU, UK

T +44 (0)1424 856600

F +44 (0)1424 856611

E sales@marshall-tufflex.com

Technical Hotline: +44 (0)1424 856688

www.marshall-tufflex.com

**Republic of Ireland &
Northern Ireland distributor**

Core Electrical Ltd
17b Goldenbridge Industrial Estate
Tyrconnell Road, Inchicore
Dublin 8

T +353 (0)1453 7033

F +353 (0)1453 8911



In pursuance of our policy of continued improvement
Marshall-Tufflex reserves the right to change the design
or specification of its products without notification.

05.09.16